

# MAGNAVOX

## MS1940B Owner's Manual



### Read this manual first!

Congratulations on purchasing this product. If you have any problems, our Representatives can help you get the most from your new product by explaining:

- Hookups
- First Time Setup, and
- Feature Operation

Do not attempt to return this product to the store.

**For fast help, call us first!**

**1-800-531-0039**

Thank you for making us a part of your home!

## TABLE OF CONTENTS

### Getting Started

Warning/Precautions	1
Features	1
Registration	1
Hooking Up Your TV (Antenna/Cable Connections)	2
VCR Connections	3
Audio/Video In Jacks	3
Auto Install	3
Basic TV and Remote Control Operation	4

### Features

Channel Edit	4
Language	5
Volume	5
Sleeptimer	5
Stereo Sound	5
SmartLock™	6
SmartLock Review	6
SmartLock Access Code	7
Picture Adjustments	7
Closed Captioning	7

### General Information

Glossary	7
Tips	8
Index	8
Warranty	8

Copyright 2001 by Philips Consumer Electronics. All rights reserved. SmartLock is a trademark of Philips Consumer Electronics.

**Federal Communications Commission Warning: Any unauthorized changes or modifications to this equipment void the user's authority to operate it.**

### For Customer Use

Enter below the Model Number and the Serial Number of your television (located on the back of the TV). Keep this information for future reference.

Model No. \_\_\_\_\_  
Serial No. \_\_\_\_\_

This manual, your new product, and the packaging contain materials that can be recycled and reused. Specialized companies can recycle your product to increase the amount of reusable materials and to minimize the amount that needs to be disposed properly. Your product uses batteries that should not be thrown away when depleted but should be disposed as small chemical waste. Please find out about the local regulations on disposal of your old product, batteries, manual, and packaging whenever you replace existing equipment.



**This owner's manual is made of recycled paper.**

## FEATURES

- **Infrared Remote Control** operates your TV and helps you set up on-screen features.
- **Standard Broadcast (VHF/UHF) or Cable TV (CATV) channel capability**
- **Closed Captioning** allows you to read TV program dialogue as on-screen text.
- **Auto Install** quickly and easily selects channels available in your area.
- **Sleeptimer** automatically turns off the TV at preset times.
- **Language Selection** allows you to choose English or Spanish on-screen menus. This does not affect the language of Closed Captioning.
- **SmartLock™** lets you control what channels or programming can be watched. If a program's rating meets or exceeds the limit you select, you must enter an access code before you can view the programming.
- **Automatic Shut Off** turns off the TV after approximately 15 minutes when it is on a channel that is not receiving a broadcast signal (for example, if a station has gone off the air for the night).

## Return your Warranty Registration card today to ensure you receive all the benefits you're entitled to.

Once your MAGNAVOX purchase is registered, you're eligible to receive all the privileges of owning a MAGNAVOX product. So complete and return the Warranty Registration Card enclosed with your purchase at once. And take advantage of these important benefits.

### Warranty Verification

Registering your product within 10 days confirms your right to maximum protection under the terms and conditions of your MAGNAVOX warranty.

### Owner Confirmation

Your completed Warranty Registration Card serves as verification of ownership in the event of product theft or loss.

### Model Registration

Returning your Warranty Registration Card right away guarantees you'll receive all the information and special offers which you qualify for as the owner of your model.

Congratulations on your purchase, and welcome to the "family!"

**MAGNAVOX**  
Smart. Very smart.®



Dear MAGNAVOX product owner:

Thank you for your confidence in MAGNAVOX. You've selected one of the best-built, best-backed products available today. And we'll do everything in our power to keep you happy with your purchase for many years to come.

As a member of the MAGNAVOX "family," you're entitled to protection by one of the most comprehensive warranties and outstanding service networks in the industry.

What's more, your purchase guarantees you'll receive all the information and special offers for which you qualify, plus easy access to accessories from our convenient home shopping network.

And most importantly you can count on our uncompromising commitment to your total satisfaction.

All of this is our way of saying welcome—and thanks for investing in a MAGNAVOX product.

P.S. Remember, to get the most from your MAGNAVOX product, you must return your Warranty Registration Card within 10 days. So please mail it to us right now!

## Know these safety symbols



⚡ This "bolt of lightning" indicates uninsulated material within your unit which may cause an electrical shock. For the safety of everyone in your household, please do not remove product covering.

⚠ The "exclamation point" calls attention to features for which you should read the enclosed literature closely to prevent operating and maintenance problems.

**WARNING: TO PREVENT FIRE OR SHOCK HAZARD, DO NOT EXPOSE THIS EQUIPMENT TO RAIN OR MOISTURE.**

**CAUTION:** To prevent electric shock, match wide blade of plug to wide slot and fully insert.

**ATTENTION:** Pour éviter les choc électriques, introduire la lame la plus large de la fiche dans la borne correspondante de la prise et pousser jusqu'au fond.

# HOOKING UP YOUR TV (ANTENNA/CABLE CONNECTIONS)

## ANTENNA

### COMBINATION UHF/VHF

A combination antenna receives normal broadcast channels (VHF 2-13 and UHF 14-69). Your connection is easy since there is only one 75Ω (ohm) antenna jack on the back of your TV - and that's where the antenna goes.

**BEGIN**

**1** If your antenna has a round connector (75Ω), then you're ready to connect it to the TV.  
**If your antenna has flat twin-lead wire (300Ω), you first need to attach the antenna wires to the screws on a 300 to 75Ω adaptor.**

**2** Push the round end of the adaptor (or cable) onto the ANT(enna) IN jack on the back of the TV. If the round end of the adaptor or cable is threaded, screw it down tight.

**STOP**

### SMART HELP



To set the TV to select only the channel numbers in your area, see Auto Install on page 3.

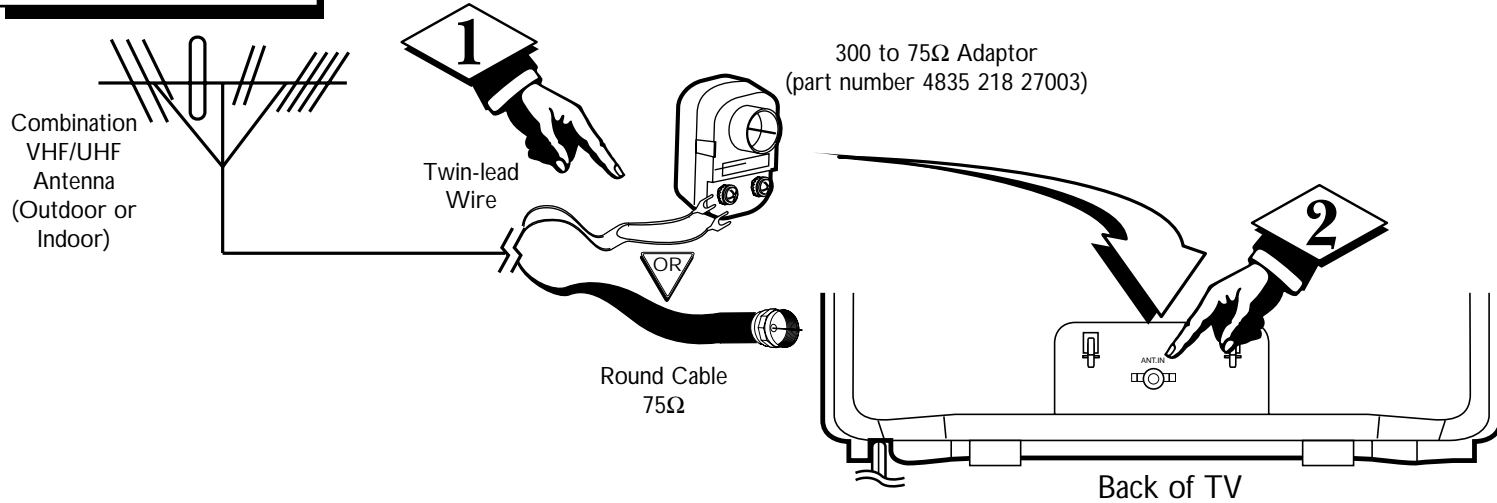

### SEPARATE UHF/VHF

You may have two separate antennas. One antenna is for VHF channels (2-13) and the other antenna is for UHF channels (14-69). For homes with separate UHF/VHF antennas, you will need an optional combiner before you can connect the antennas to the TV.

**BEGIN**

**1** Attach the separate UHF and VHF antennas to the correct screws on the combiner.

**2** Push the round end of the combiner onto the ANT(enna) IN jack on the back of the TV.

**STOP**

### SMART HELP



To order any optional accessory, contact your dealer. Or, call 1-800-851-8885 and refer to the following part numbers to order.

- UHF/VHF Combiner: 4835 466 97016
- 75-300Ω Adaptor: M61009
- 300-75Ω Adaptor: 4835 218 27003

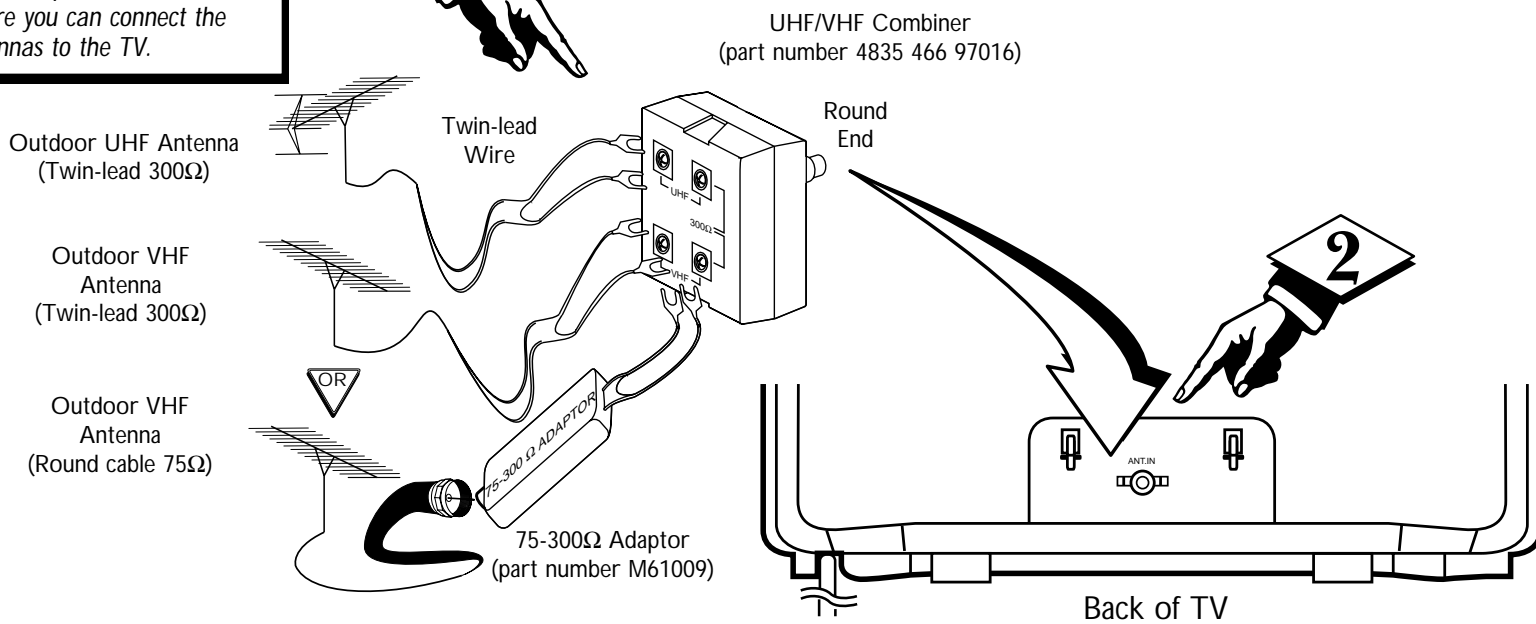

## CABLE TV

### CABLE/CABLE BOX

Your Cable TV signal may be a single (75Ω) cable or a Cable Box installation. In either case, the connection to the TV is very easy.

**BEGIN**

**1** If you do not have a Cable Box, then you're ready to connect your Cable TV signal to the TV. Go to step 2.  
**If you have a Cable Box:** Connect the Cable TV signal to the IN jack on the Cable Box.

**2** If you do not have a Cable Box, connect the Cable TV signal directly to the ANT(enna) IN jack on the TV.  
**If you have a Cable Box:** Use a coaxial cable to connect the OUT jack of the Cable Box to the ANT(enna) IN jack on the TV.  
**NOTE:** The coaxial cable might be supplied by the Cable TV company.

**STOP**

### SMART HELP



To select only the channels on your Cable system, see Auto Install (page 3).

If you use a Cable Box, set the TV to the same channel as the CH 3/4 switch on the back of the Cable Box and select channels at the Cable Box.

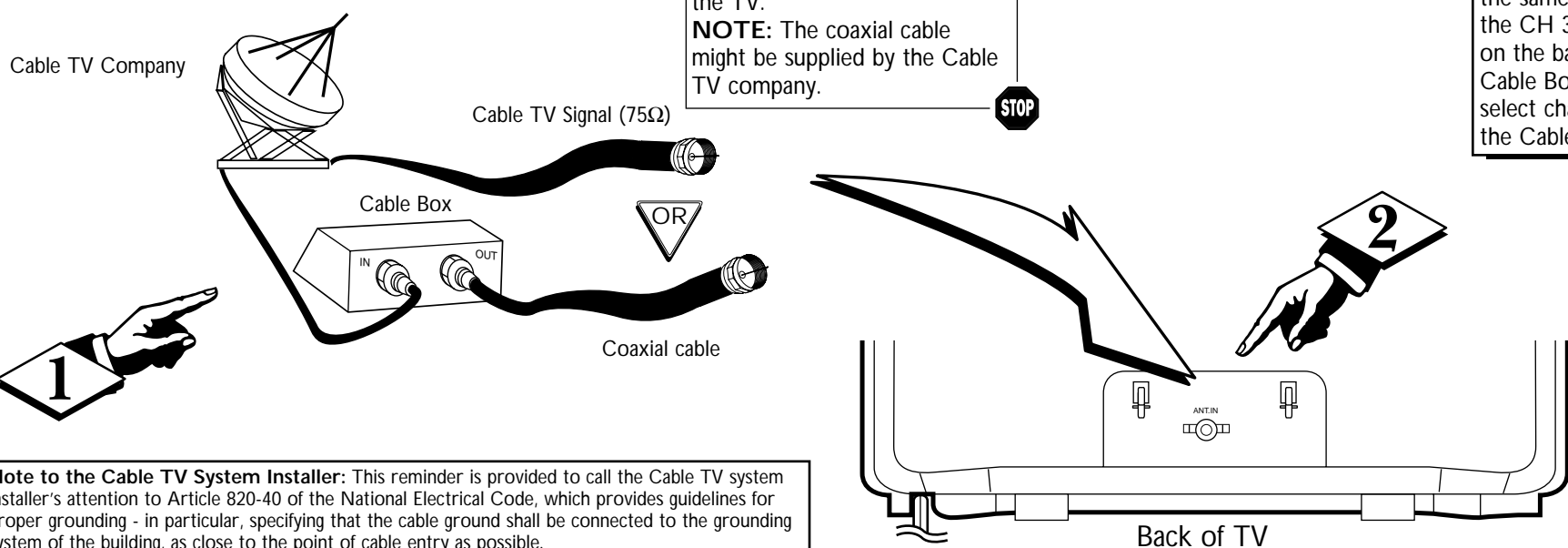

**Note to the Cable TV System Installer:** This reminder is provided to call the Cable TV system installer's attention to Article 820-40 of the National Electrical Code, which provides guidelines for proper grounding - in particular, specifying that the cable ground shall be connected to the grounding system of the building, as close to the point of cable entry as possible.

# HOOKING UP YOUR TV (ANTENNA/CABLE CONNECTIONS) (CONT'D)

## VCR TO TV

**BEGIN**

### BASIC CONNECTION

The basic Antenna/Cable to VCR to TV connection is shown here. If you have a Cable Box, refer to the VCR owner's manual for details.

**1** Connect your Antenna or Cable signal to the ANTENNA IN jack on the VCR.

**2** Connect a coaxial cable to the RF OUT or ANTENNA OUT jack on the VCR and to the ANT(enna) IN jack on the TV.  
The coaxial cable may be supplied with the VCR.

**3** Refer to the VCR owner's manual for other possible connections and for operating details.

**STOP**

## USING THE FRONT AUDIO/VIDEO IN JACKS

**BEGIN**

### AUDIO/VIDEO IN JACKS

For more convenient tape playback from a camcorder or VCR, use the AUDIO and VIDEO In jacks on the front of the TV. These easily accessible jacks allow quick connections between the TV and the VCR, camcorder, or other video equipment.

**1** Connect a video cable (not supplied) to the VIDEO OUT jack of the camcorder/VCR and to the VIDEO In jack on the front of the TV.

**2** Connect audio cables (not supplied) to the AUDIO OUT jacks of the camcorder/VCR and to the AUDIO In jacks on the front of the TV.

**3** When you play a tape, select A/V IN at the TV. Press the TV/AUX button to select A/V IN. A/V IN will appear on the screen.

**4** Turn on the camcorder/VCR and press the PLAY button on the camcorder/VCR. When you are finished watching the tape, press the STOP button on the camcorder/VCR.

**STOP**

### SMART HELP

When you are finished watching the tape, press the TV/AUX button on the TV remote control to return to viewing normal TV channels.

# SETTING UP AND USING YOUR TV

## AUTO INSTALL

**BEGIN**

Follow these steps to quickly add area channels into the TV's memory.

**1** Press the POWER button to turn ON the TV. Make sure you are not in A/V IN mode. (Press the TV/AUX button so that A/V IN does not appear on the screen.)

**2** Press the MENU button. The main menu appears on the TV screen.

SETUP	▶
EXIT	▶
BRIGHTNESS	■■■■■■ 24
COLOR	■■■■■■ 31
PICTURE	■■■■■■ 31

**3** Press the CH(annel) ▲/▼ buttons to select SETUP. Then, press the VOL(ume) ▶ or ◀ button to continue to the SETUP menu.

EXIT	▶
LANGUAGE	▶ ENG
AUTO INSTALL	▶
CHANNEL EDIT	▶

**4** Press the CH(annel) ▲/▼ buttons to select AUTO INSTALL. Then, press the VOL(ume) ▶ or ◀ button to enter AUTO INSTALL, which will set up the channels automatically.

AUTO STORE	■■■■■■ 31
------------	-----------

When setup is complete, the SETUP menu will appear for a moment, then the lowest stored channel will appear. Now, when you press the CH(annel) ▲/▼ buttons, you will only scan through channels that are available. You still may select non-memorized channels by pressing the Number buttons.

**STOP**

# SETTING UP AND USING YOUR TV (CONT'D)

## REMOTE

To load the batteries into the remote:

1. Press in the tab on the battery compartment lid on the bottom of the remote control, then lift off the lid.
2. Insert two AA batteries (supplied) into the battery compartment as indicated inside the compartment. Installing batteries incorrectly may damage the remote control.
3. Replace the lid.

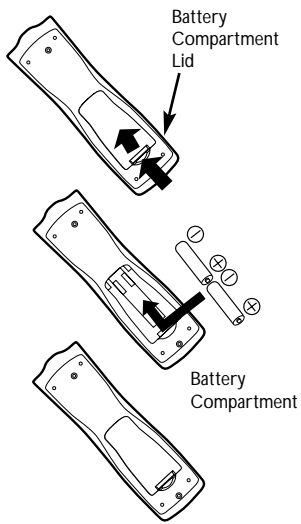

## (BEGIN)

1. Point the remote control toward the remote sensor on the TV when operating the TV with the remote. (See Television illustration below.)

**SLEEP Button**  
Press to set the TV to turn itself OFF automatically. Details are on page 5.

**Number Buttons**  
Press to select channels.

• **Cable Users**  
Enter channel numbers as a two-digit number for the quickest results. For example, to select channel 6, press 0,6. If you only press the Number 6 button, channel 6 will be selected after a brief delay. (There also may be a brief delay when you select channels 10, 11, and 12.) If you want to select channels 100 and above, enter channel numbers as a three-digit number. For example, to select channel 117, press 1, 1, 7.

• **Antenna Users**  
Enter channel numbers as a two-digit number for the quickest results. For example, to select channel 5, press 0,5. If you only press the Number 5 button, channel 5 will be selected after a brief delay. You may only select channels 2-69.

**STATUS/EXIT Button**  
Press to see the current channel number on the TV screen. Press to remove the on-screen menu. You also may remove the menu by pressing the CH(annel) ▲/▼ buttons to select EXIT, then pressing the VOL(ume) ►/◄ buttons. (You may need to select EXIT repeatedly to completely remove all of the menus.)

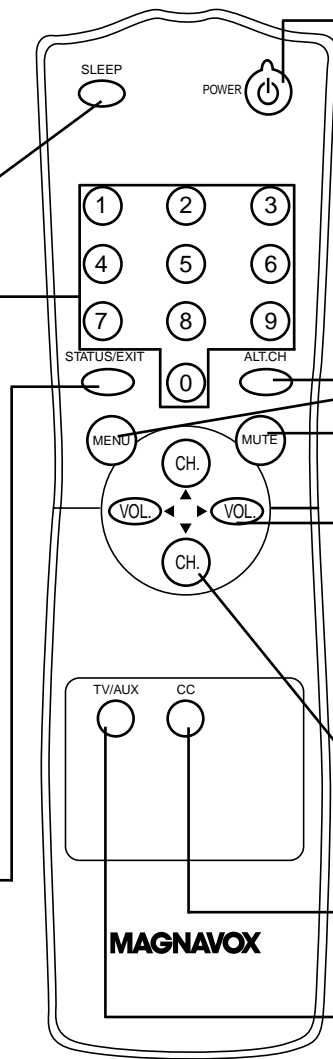

**POWER Button**  
Press to turn the TV ON and OFF.

**ALT. CH (Alternate Channel) Button**  
Press to return to the TV channel you were viewing immediately before switching to your current channel.

**MENU Button**  
Press to access or remove the on-screen menu. Press the CH(annel) ▲/▼ buttons to select an item in the menu. Press the VOL(ume) ►/◄ buttons to adjust an item in the menu or to advance to the next menu.

**MUTE Button**  
Press to turn OFF the sound on the TV. Press again to restore the sound.

**VOL(ume) ►/◄ Buttons**  
Press to adjust the TV sound level. Press to adjust an item in the on-screen menu or to advance to the next menu.

If you press the VOL(ume) ◄ button when the sound is muted, the volume indicator will appear on the screen. Pressing the VOL(ume) ► button when the sound is muted will restore the sound.

**CH(annel) ▲/▼ Buttons**  
Press to scan through available channels. Details are on page 3. Press to select an item in the on-screen menu.

**CC (Closed Caption) Button**  
Press repeatedly to select a Closed Caption mode. Details are on page 7.

**TV/AUX Button**  
Press to select A/V IN (for viewing video playback at the TV from a VCR, camcorder, DVD Player, etc.). Press again to return to another TV channel. Details are on page 3.

## TELEVISION

## (BEGIN)

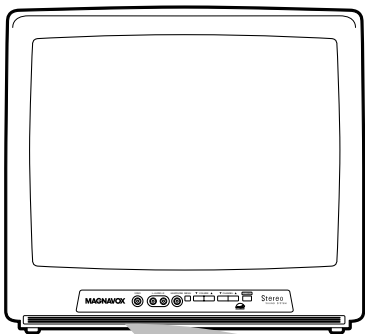

1. Press the **POWER button** to turn ON the TV. Be sure to connect the TV power cord to a standard AC outlet first.

2. Press the **VOLUME ▲/▼ buttons** to adjust the sound level.

3. Press the **CHANNEL ▲/▼ buttons** to select available TV channels. (See Auto Install on page 3.)

4. Press the **MENU button** to display the TV's on-screen menu.

Press the **CHANNEL ▲/▼ buttons** to select an item in the menu. Press the **VOLUME ▲/▼ buttons** to adjust an item in the menu or to advance to the next menu.

**Note:** To remove the menu, press the **CHANNEL ▲/▼ buttons** to select EXIT. Then, press the **VOLUME ▲** or **▼** button. (You may need to select EXIT repeatedly to completely remove all of the menus.) Or, press the **MENU button**, repeatedly if necessary, to remove the MENU.

## SMART HELP

The current channel number will appear briefly when the TV is first turned ON and with channel changes. To display the channel number for five seconds, press the **STATUS/EXIT button**.

You can turn on the TV by pressing the **CHANNEL ▲/▼ buttons** on the front of the TV. The **CH(annel) ▲/▼ buttons** of the remote control will not turn on the TV power.

### Note:

- You can connect headphones (not supplied) to the HEADPHONE jack on the front of the TV for private, personal listening.
- You can connect the AUDIO/VIDEO In jacks on the front of the TV to the AUDIO/VIDEO OUT jacks of a camcorder, VCR, or other video equipment. Details are on page 3.

## FEATURES

## CHANNEL EDIT

## (BEGIN)

**AUTO INSTALL** (see page 3) memorizes all the channels on your Antenna or Cable TV system. **CHANNEL EDIT** makes it easy for you to add other channels or drop unwanted channels from the TV's memory. Then, when you use the **CH(annel) ▲/▼ buttons**, you will only scan through the channels you want.

1. Press the **MENU button**, then press the **CH(annel) ▲/▼ buttons** to select **SETUP**.

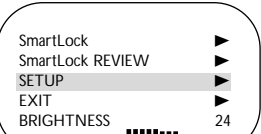

2. Press the **VOL(ume) ► or ◄ button** to continue to the **SETUP** menu.

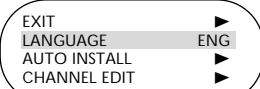

3. Press the **CH(annel) ▲/▼ buttons** to select **CHANNEL EDIT**.

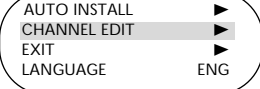

4. Press the **VOL(ume) ► or ◄ button** to continue to the **CHANNEL EDIT** menu. CHANNEL will be selected.

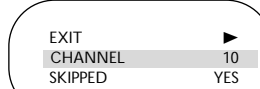

5. While **CHANNEL** is selected, press the **VOL(ume) ► or ◄ button** or the **Number buttons** to select the channel you want to add or skip.

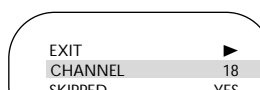

6. Press the **CH(annel) ▲/▼ buttons** to select **SKIPPED**. Then, press the **VOL(ume) ► or ◄ button** to set **SKIPPED** to **YES** (if you want to skip past the channel when using the **CH(annel) ▲/▼ buttons**) or **NO** (if you want the channel to be available when you are using the **CH(annel) ▲/▼ buttons**).

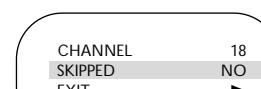

7. Press the **STATUS/EXIT button** when you are finished.

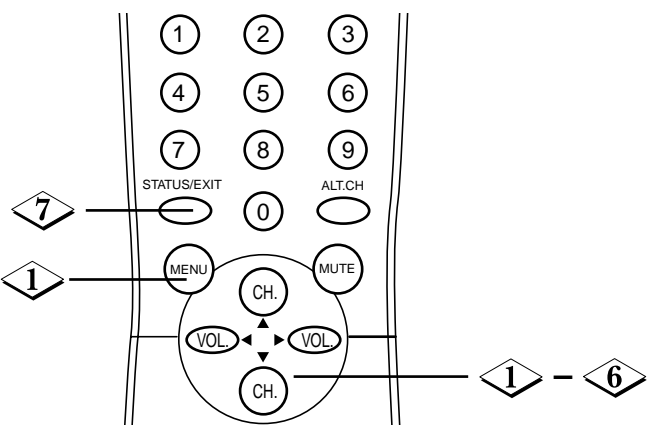

# FEATURES (CONT'D)

## LANGUAGE

Follow these steps to change the language of the on-screen menus and displays.

### BEGIN

1 Press the MENU button.



2 Press the CH(annel) ▲/▼ buttons to select SETUP, then press the VOL(ume) ► or ◀ button to continue. LANGUAGE will be selected.

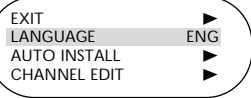

3 Press the VOL(ume) ► or ◀ button to select ENG for English menus or ESP for Spanish menus.

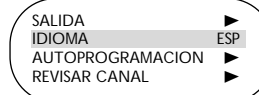
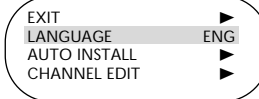

4 Press the STATUS/EXIT button.

STOP

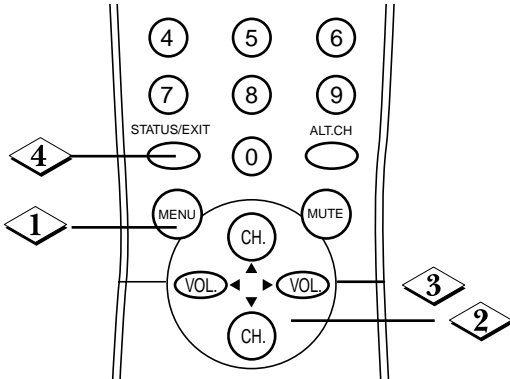

## SMART HELP

If you accidentally chose Spanish and need English:

- 1) Press the MENU button.
- 2) Press the CH(annel) ▲/▼ buttons to select INSTALACION, then press the VOL(ume) ► or ◀ button to continue.
- 3) IDIOMA will be selected. Press the VOL(ume) ► or ◀ button to have ENG appear beside LANGUAGE.
- 4) Press the STATUS/EXIT button.

## VOLUME

There are two ways to adjust the TV's volume. Follow these steps to adjust the volume using the on-screen menu. Or, you can adjust the volume using the VOL(ume) ►/◀ buttons on the remote control or the VOLUME ▲/▼ buttons on the TV.

### BEGIN

1 Press the MENU button.

2 Press the CH(annel) ▲/▼ buttons to select VOLUME. Then, press the VOL(ume) ►/◀ buttons to adjust the volume level. Pressing the VOL(ume) ► button when the sound is muted will restore the sound.

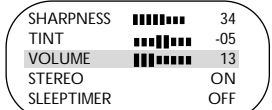

3 Press the STATUS/EXIT button to remove the menu.

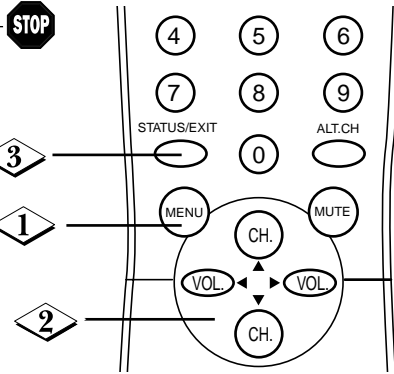

## SMART HELP

The Volume indicator should appear on the screen when you adjust the volume. The simplest way to adjust the volume is by pressing the VOL(ume) ►/◀ buttons.

## SLEEPTIMER

Have you ever fallen asleep in front of the TV, only to have it wake you up at 2 a.m. with a test pattern screeching in your ears? Well, your TV can save you all that trouble by automatically turning itself off. Set the Sleptimer simply by pressing the SLEEP button, or you may use the on-screen menu.

### BEGIN

1 Press the SLEEP button repeatedly to pick the amount of time (15 minutes to 120 minutes) before the TV turns itself off. The length of time will appear on the screen briefly. One minute before the TV shuts itself off, the seconds will count down on the screen.

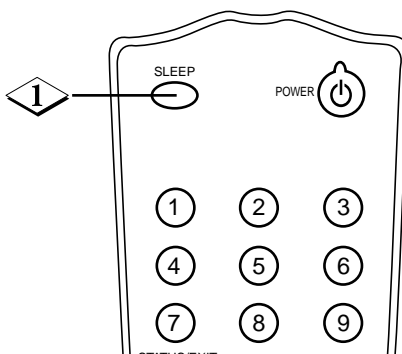

1 Press the MENU button.

2 Press the CH(annel) ▲/▼ buttons to select SLEEPTIMER.

3 Press the VOL(ume) ►/◀ buttons repeatedly to set the amount of time or to select OFF.

4 Press the STATUS/EXIT button to remove the menu.

STOP

OR

## SMART HELP

To see how many minutes remain before the TV shuts itself off, press the SLEEP button once or press the STATUS/EXIT button. To cancel a SLEEPTIMER setting, press the SLEEP button twice so that OFF appears on the screen. A power failure will cancel the Sleptimer. You may reset the Sleptimer.

## STEREO SOUND

You can enjoy stereo sound (when broadcasted) at the TV by following these steps.

### BEGIN

1 Press the MENU button, then press the CH(annel) ▲/▼ buttons to select STEREO.

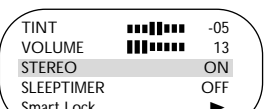

2 Press the VOL(ume) ►/◀ buttons to set STEREO to ON or OFF.

3 Press the STATUS/EXIT button to remove the menu.

STOP

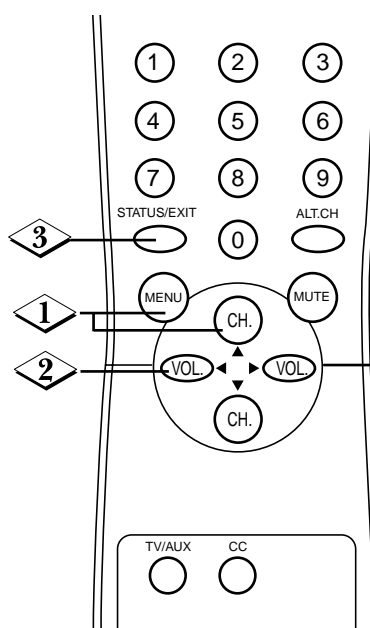

## SMART HELP

If STEREO is ON, when the TV detects a stereo signal, the sound becomes stereo. STEREO will appear under the channel number on the screen. If STEREO is OFF, the sound will be monaural, even if the TV channel is broadcasting in stereo.

# FEATURES (CONT'D)

## SMARTLOCK

SmartLock enables parents to prevent their children from watching inappropriate material on TV. SmartLock reads the ratings for programming (except for news and sports programs, unedited movies on premium cable channels, and Emergency Broadcast System signals), then denies access to programming if the program's rating meets or exceeds the limitations you select. To block specific ratings or channels, follow these steps.

### BEGIN

**1** Press the MENU button, then press the CH(annel) ▲/▼ buttons to select SmartLock. Then, press the VOL(ume) ► or ◀ button to continue.

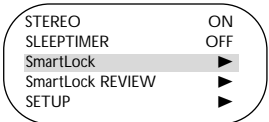

**2** Use the Number buttons to enter your 4-digit access code. The default code is 0711. If you have not set up your personal access code, you should use 0711.

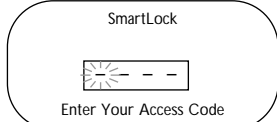

**3** BLOCK will be selected. Press the VOL(ume) ► or ◀ button to continue.

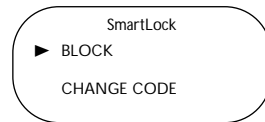

**4** Press the CH(annel) ▲/▼ buttons to select Blocking Options, Channels Blocked, Movie Ratings or Parental Guidelines. Then, press the VOL(ume) ► or ◀ button to continue.

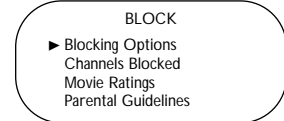

**5** If you selected Blocking Options at step 4: Press the CH(annel) ▲/▼ buttons to select Master Disable, Block Unrated or Block No Rating. Then, press the VOL(ume) ► or ◀ button to select ON or OFF. Blocking Options are described at right. To return to the main BLOCK menu, press the MENU button once.

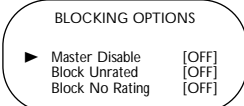

If you selected Channels Blocked at step 4: Channel will be selected. Press the VOL(ume) ► or ◀ button or use the Number buttons to select the channel you want to block. Press the CH(annel) ▲/▼ buttons to select Blocked, then press the VOL(ume) ► or ◀ button to select ON or OFF. If Blocked is ON, you can not watch the channel until you enter the access code.

To reset all channels for viewing, press the CH(annel) ▲/▼ buttons to select Clear All, then press the VOL(ume) ► or ◀ button. (Channel will be selected again.) Remember, viewing could still be blocked by another SmartLock setting (such as Movie Ratings). To return to the main BLOCK menu, press the MENU button once.

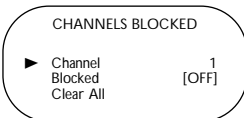

If you selected Movie Ratings or Parental Guidelines at step 4: Press the CH(annel) ▲/▼ buttons to select the rating you want to block. Then, press the VOL(ume) ► or ◀ button so that ON appears beside the rating.

For example, if you set PG to ON, you may not view PG programming because the block is on. Programs with a PG or higher rating will be blocked.

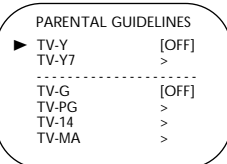
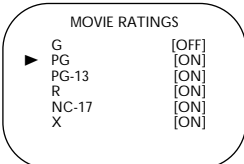

• More specific sub-ratings are available for TV-Y7, TV-PG, TV-14, and TV-MA. When you press the VOL(ume) ►/◀ buttons to select TV-Y7, TV-PG, TV-14 or TV-MA, additional sub-ratings will appear. Press the VOL(ume) ► or ◀ button to set the main rating to ON. Then, press the CH(annel) ▲/▼ buttons to select a specific sub-rating. Then, press the VOL(ume) ►/◀ buttons so that ON appears beside the sub-rating. If you select the main rating and turn it on or off, the sub-ratings will turn on or off automatically. But, you can always turn sub-ratings on or off by selecting them individually. You can only turn on a sub-rating (for example, D) if the main rating (such as TV-PG) is set to ON.

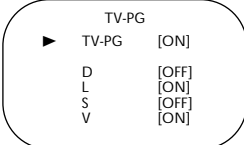

**6** Press the STATUS/EXIT button.

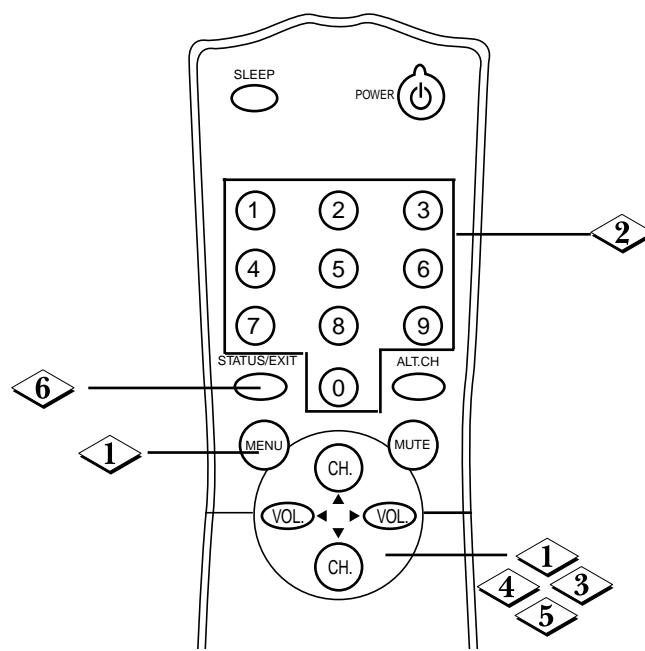

## SMART HELP



To set a new access code, see SmartLock Access Code on page 7.

If the "Incorrect Access Code..." message appears after step 2, enter the correct access code. In order to protect the privacy of the access code, an X will appear on the screen instead of the number you enter.

A "CHANNEL XX BLOCKED..." message will appear when someone tries to access the blocked programming. If you want to view this programming, enter your access code. The channel will remain blocked until you enter the correct code. If you do not know the code, you must select another channel using the CH(annel) ▲/▼ buttons (not the Number buttons). Turning off the TV blocks the programming again.

If the "CHANNEL XX BLOCKED..." message appears and you do not remember your personal access code, enter 0711 twice. The CHANGE CODE menu will appear. See SmartLock Access Code on page 7.

### BLOCKING OPTIONS

- **Master Disable**  
When Master Disable is ON, all settings of Channels Blocked, Movie Ratings, Parental Guidelines, Block Unrated, and Block No Rating are ineffective. SmartLock DISABLED will appear when you look at SmartLock Review. All programming may be viewed.
- **Block Unrated**  
When Block Unrated is ON, TV programs are blocked when the show is broadcast as Unrated.
- **Block No Rating**  
When Block No Rating is ON, TV programs are blocked when the show is broadcast without rating information.

### PARENTAL GUIDELINES RATING EXPLANATIONS

- V-Violence
- S-Sexual situations
- L-Language
- D-Inappropriate dialogue
- FV-Fantasy Violence, may frighten children under seven; TV-Y7 category only. Some cartoons may have this rating.
- TV-Y - Appropriate for all children
- TV-Y7 - Appropriate for children seven and older
- TV-G - General Audience
- TV-PG - Parental Guidance suggested.
- TV-14 - Unsuitable for children under 14
- TV-MA - Mature audience only

## SMARTLOCK REVIEW

To check your SmartLock settings, follow these steps. You will know what types of programming and which channels you have blocked from viewing.

## SMART HELP



If you do not use the VOL(ume) ► or ◀ button to advance through the SmartLock REVIEW screens, the screens will advance automatically within 10 seconds.

### BEGIN

**1** Press the MENU button, then press the CH(annel) ▲/▼ buttons to select SmartLock REVIEW. (If Master Disable is ON, SmartLock DISABLED will appear when you select SmartLock REVIEW.)

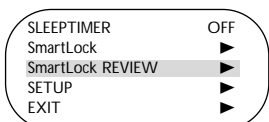

**2** Press the VOL(ume) ► or ◀ button so that the SmartLock settings for Movie Ratings and Parental Guidelines appear. Ratings that are blocked will appear on the screen. An "X" will appear if a specific sub-rating is blocked, such as V for Violence in the TV-14 category.

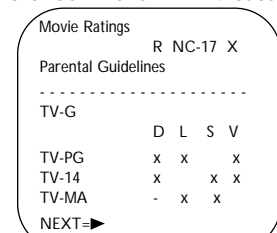

**3** Press the VOL(ume) ► or ◀ button to advance to the Channels Blocked screen. All currently blocked channels will appear.

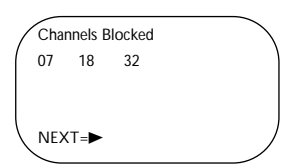

**4** Press the VOL(ume) ► or ◀ button to advance to the Block Unrated and Block No Rating screen, which shows if these options are set to On or Off.

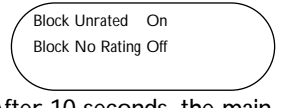

After 10 seconds, the main menu will reappear. Repeat steps 2-4 as often as necessary in order to review all the settings.

**5** When you are finished, press the STATUS/EXIT button.



# FEATURES (CONT'D)

## SMARTLOCK ACCESS CODE

To change the access code, follow these steps.

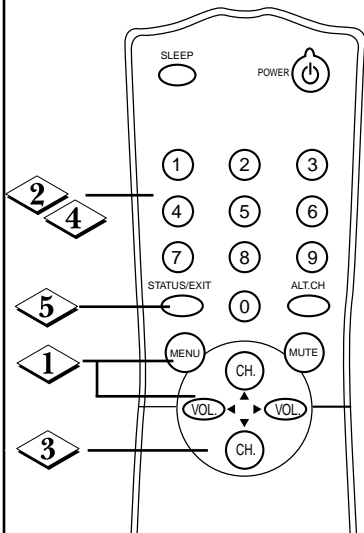

### BEGIN

1 Press the MENU button, then press the CH(annel) ▲/▼ buttons to select SmartLock. Press the VOL(ume) ► or ◀ button to continue.

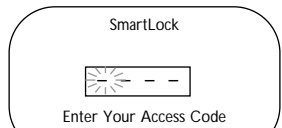
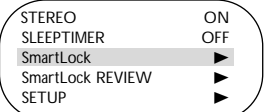

2 Press the Number buttons to enter your old access code. If you have never set up your personal access code, use 0711. If you do not know the old code, enter 0711 TWICE.

3 Press the CH(annel) ▲/▼ buttons to select CHANGE CODE. Then, press the VOL(ume) ► or ◀ button to continue.

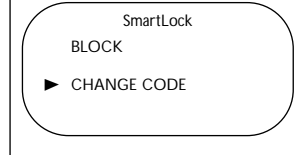

4 Use the Number buttons to enter your desired access code in the New Code space. Then, enter the same code in the Confirm Code space. Your new access code is set. You will return to the SmartLock menu.

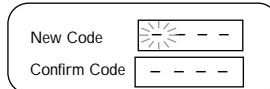

If "Wrong Code Code Unchanged" appears, repeat step 4, making sure you enter the same new code exactly in the Confirm Code space.

5 Press the STATUS/EXIT button.

## SMART HELP



You cannot use the default code after you set up your personal access code.

To restore 0711 as your personal access code, unplug the TV's power cord for 10 seconds, then plug it in again. This is helpful when you forget your personal access code.

## PICTURE ADJUSTMENTS

To adjust your TV picture controls, select a channel and follow these steps.

### BEGIN

1 Press the MENU button, then press the CH(annel) ▲/▼ buttons to select a control.



2 Press the VOL(ume) ►/◀ buttons to adjust the selected picture control.

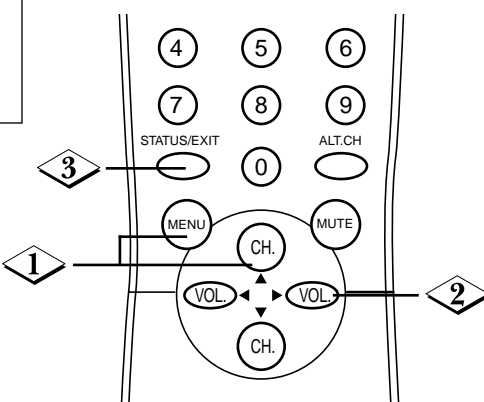

3 Press the STATUS/EXIT button.

**BRIGHTNESS** Press the VOL(ume) ►/◀ buttons until the darkest parts of the picture are as bright as you prefer.

**COLOR** Press the VOL(ume) ►/◀ buttons to add or reduce color.

**PICTURE** Press the VOL(ume) ►/◀ buttons until the lightest parts of the picture show good detail.

**SHARPNESS** Press the VOL(ume) ►/◀ buttons to improve detail in the picture.

**TINT** Press the VOL(ume) ►/◀ buttons to obtain natural skin tones.

## CLOSED CAPTIONING

Closed Captioning allows you to read the voice content of television programs on the TV screen. Designed to help the hearing impaired, this feature uses on-screen text boxes to show dialogue and conversations while the TV program is in progress. Note: Broadcast stations will often use spelling abbreviations, symbols, dropouts and other grammatical shortcuts in order to keep pace with the on-screen action. These factors vary with the source of the captioned text material and do not indicate a need for TV service.

### BEGIN

1 Press the CC button repeatedly until the desired Closed Caption mode appears on the screen. You may choose CAPTION 1, CAPTION 2, TEXT 1, TEXT 2, or CAPTION OFF.

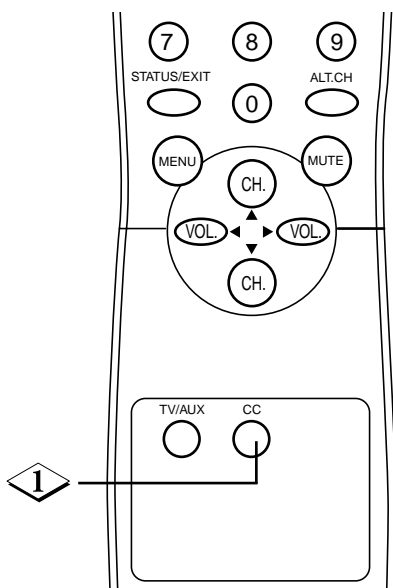

### Notes:

- Usually CAPTION 1 is the preferred Closed Caption mode.
- CAPTION 1 or 2:** Dialogue (and descriptions) for the action on the captioned TV program shows on the screen.
- TEXT 1 or 2:** A black box appears on the TV screen. If the TEXT mode is available with the current TV program, text or information will appear.
- CAPTION OFF:** Select to turn off Closed Captions completely.
- Captions and texts may not match the TV voice broadcast exactly.
- Interference or a weak antenna/cable signal may cause the Closed Captioning system to function improperly.
- The caption or text characters will not appear if the menu is on the screen.
- Remember, not all TV programs and commercials are broadcast with Closed Captioning. Neither are all Closed Caption modes necessarily being used by a broadcast station during the transmission of a program. Refer to your area's TV program listings for the stations and times of shows with Closed Captioning.
- If a black box appears on the screen, you have selected TEXT 1 or TEXT 2. To remove the black box, select CAPTION 1, CAPTION 2, or CAPTION OFF.



## SMART HELP



Closed Captions will be interrupted briefly when you mute or adjust the volume, change channels, or press the STATUS/EXIT button to see the current channel number.

## GLOSSARY

**Coaxial Cable** - A single cable with a metal connector that screws (or pushes) directly onto a 75Ω jack (ANT(enna) In jack) on the Television or VCR.

**Display** - Allows the user to quickly confirm the current channel number.

**Jack Panel** - The area on the back of the TV.

**Menu** - An on-screen listing of features that are available for adjustments.

**On-screen Displays (OSDs)** - The wording or messages that help you set up features (color adjustment, channel setup, etc.).

**Programming** - Adding or deleting channels in the television's memory. The television "remembers" only the locally available or desired channel numbers and skips over any unwanted channel numbers.

**Remote Sensor** - An area on the front of the TV through which remote control signals are received.

**Twin Lead Wire** - The two-strand 300Ω antenna wire used with many indoor and outdoor antenna systems. In many cases, this type of antenna wire requires an additional adaptor (or balun) in order to connect to the ANT(enna) In jack on the TV.

**Volume Indicator** - Appears on the TV screen when you adjust the volume.

# GENERAL INFORMATION



## TIPS

### TROUBLESHOOTING

Please make these simple checks before calling for service. These tips can save you time and money since charges for TV installation and adjustment of customer controls are not covered under your warranty.

### Battery Safety

To prevent battery leakage that may result in bodily injury or damage to the unit:

- Install ALL batteries correctly, with the + and - markings on the battery aligned as indicated on the unit;
- Do not mix batteries, for example, old with new or carbon with alkaline; and
- Remove batteries when the unit will not be used for a long time.

## BEGIN

1

### No Power

- Check the TV power cord.
- Make sure the power outlet is not on a wall switch.

2

### No Sound

- Check the VOL(ume) ►/◄ buttons.
- Check the MUTE button.

3

### No Picture

- Check antenna/cable connections. Is the antenna or cable properly secured to the ANT(enna) IN jack on the TV? See pages 2-3 for details.

4

### Remote Doesn't Work

- Check batteries. Replace with AA Heavy Duty (Zinc Chloride) or Alkaline batteries if necessary.
- Clean the remote and the remote sensor on the TV. See page 4.
- Check the TV power cord.

5

### Wrong Channel

- Repeat channel selection. Refer to Number Buttons on page 4.
- Add desired channel numbers into the TV memory. See Channel Edit on page 4.

### Cleaning and Care

- Unplug the TV before cleaning.
- Avoid using anything abrasive that could scratch the screen.
- Wipe the TV screen with a clean cloth dampened with water.
- Gently wipe cabinet surfaces with a clean cloth or sponge dampened with cool clear water. Use a clean dry cloth to dry the wiped surfaces.
- Occasionally vacuum the ventilation holes or slots in the cabinet back.
- Never use thinners, insecticide sprays, or other chemicals on or near the cabinet.

### SmartLock

- Programming may be rated by the Motion Picture Association of America (MPAA) or according to the Television Parental Guidelines. In order to block any inappropriate programming, set your limits in both places (Movie Ratings and Parental Guidelines).
- If you enter the access code once, you may change channels without seeing the "CHANNEL XX BLOCKED" message again. If you turn off the TV power, you will be asked for the access code again when you tune to a blocked channel.
- If the power fails, the default code, 0711, will be the active access code again. Ratings will remain blocked even after a power failure.
- If you connect the power cord to an AC outlet that is controlled by a wall switch, your personal access code will be erased every time you turn off the power at the wall switch. The default code will be the active code again.
- To restore 0711 as your personal access code, unplug the TV's power cord for 10 seconds, then plug it in again.



As an ENERGY STAR® Partner, Philips Consumer Electronics Company has determined that this product meets the ENERGY STAR® guidelines for energy efficiency. ENERGY STAR® is a U.S. registered mark.

Using products with the ENERGY STAR® label can save energy. Saving energy reduces air pollution and lowers utility bills.



## INDEX

Access Code . . . . .7	CH(annel) ▲/▼ Buttons . .4	Language . . . . .5	Remote Sensor . . . . .4	Stereo Sound . . . . .5
ALT. CH Button . . . . .4	Closed Captioning . . . . .7	MENU Button . . . . .4	Review (SmartLock) . . . . .6	Tips . . . . .8
Antenna Connections . . .2-3	Coaxial Cable . . . . .2-3	MUTE Button . . . . .4	Safety Notes . . . . .1	TV/AUX Button . . . . .3-4
Auto Install . . . . .3	Controls/Remote . . . . .4	Number Buttons . . . . .4	Service . . . . .8	VCR Connections . . . . .3
Batteries . . . . .4	Controls/TV . . . . .4	Picture Adjustments . . . . .7	SLEEP Button . . . . .4, 5	Volume . . . . .5
Cable TV Connections . . .2	Features . . . . .1	POWER Button . . . . .4	Sleeptimer . . . . .5	VOL(ume) ►/◄ Buttons 4-5
Channel Edit . . . . .4	Glossary . . . . .7	Precautions . . . . .1, 8	SmartLock . . . . .6-7	Warranty . . . . .8
Channel Setup . . . . .3	Headphone jack . . . . .4	Remote Control . . . . .4	STATUS/EXIT button . . .4	



## WARRANTY

### COLOR TELEVISION

90 Days Free Labor

One Year Free Replacement of Parts (Two Years Free Replacement on Color Picture Tube)

This product must be carried in for repair.

#### WHO IS COVERED?

You must have proof of purchase to receive warranty service. A sales receipt or other document showing that you purchased the product is considered proof of purchase.

#### WHAT IS COVERED?

Warranty coverage begins the day you buy your product. For 90 days thereafter, all parts will be repaired or replaced free, and labor is free. From 90 days to one year from the day of purchase, all parts will be repaired or replaced free, but you pay for all labor charges. From one to two years from the day of purchase, you pay for the replacement or repair of all parts except the picture tube, and for all labor charges. After two years from the day of purchase, you pay for the replacement or repair of all parts, and for all labor charges.

All parts, including repaired and replaced parts, are covered only for the original warranty period. When the warranty on the product expires, the warranty on all replaced and repaired parts also expires.

#### WHAT IS EXCLUDED?

Your warranty does not cover:

- labor charges for installation or setup of the product, adjustment of customer controls on the product, and installation or repair of antenna systems outside of the product.
- product repair and/or part replacement because of misuse, accident, unauthorized repair, or other cause not within the control of Philips Consumer Electronics Company.
- reception problems caused by signal conditions or cable or antenna systems outside the unit.
- a product that requires modification or adaptation to enable it to operate in any country other than the country for which it was designed, manufactured, approved, and/or authorized, or repair of products damaged by these modifications.
- incidental or consequential damages resulting from the product. (Some states do not allow the exclusion of incidental or consequential damages, so the above exclusion may not apply to you. This includes, but is not limited to, prerecorded material, whether copyrighted or not copyrighted.)
- a product used for commercial or institutional purposes.

#### WHERE IS SERVICE AVAILABLE?

Warranty service is available in all countries where the product is officially distributed by Philips Consumer Electronics Company. In countries where Philips Consumer Electronics Company does not distribute the product, the local Philips service organization will attempt to provide service (although there may be a delay if the appropriate spare parts and technical manual(s) are not readily available).

#### MAKE SURE YOU KEEP...

Please keep your sales receipt or other document showing proof of purchase. Attach it to this owner's manual and keep both nearby. Also keep the original box and packing material in case you need to return your product.

#### BEFORE REQUESTING SERVICE...

Please check your owner's manual before requesting service. Adjustments of the controls discussed there may save you a service call.

#### TO GET WARRANTY SERVICE IN U.S.A., PUERTO RICO, OR U.S. VIRGIN ISLANDS...

Contact a Philips factory service center (see enclosed list) or authorized service center to arrange repair.

(In U.S.A., Puerto Rico, and U.S. Virgin Islands, all implied warranties, including implied warranties of merchantability and fitness for a particular purpose, are limited in duration to the duration of this express warranty. But, because some states do not allow limitations on how long an implied warranty may last, this limitation may not apply to you.)

#### TO GET WARRANTY SERVICE IN CANADA...

Please contact Philips at:

1-800-661-6162 (French Speaking)  
1-800-363-7278 (English Speaking)

(In Canada, this warranty is given in lieu of all other warranties. No other warranties are expressed or implied, including any implied warranties of merchantability or fitness for a particular purpose. Philips is not liable under any circumstances for any direct, indirect, special, incidental, or consequential damages, howsoever incurred, even if notified of the possibility of such damages.)

#### REMEMBER...

Please record below the model and serial numbers found on the product. Also, please fill out and mail your warranty registration card promptly. It will be easier for us to notify you if necessary.

MODEL # \_\_\_\_\_  
SERIAL # \_\_\_\_\_

Philips Service Solutions Group, P.O. Box 2976, Longview, Texas 75606  
(903) 242-4800